

Cahier technique no. 208

Electronic starters and variable speed drives

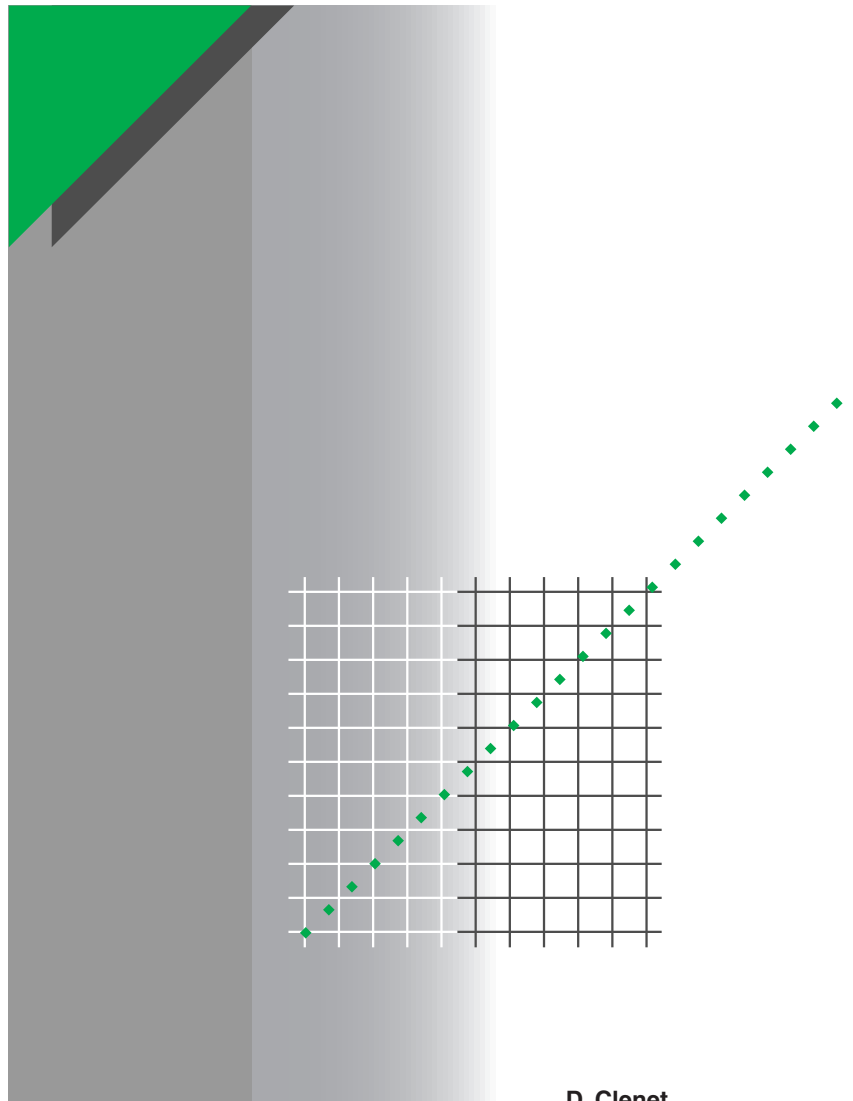

D. Clenet

"Cahiers Techniques" is a collection of documents intended for engineers and technicians, people in the industry who are looking for more in-depth information in order to complement that given in product catalogues.

Furthermore, these "Cahiers Techniques" are often considered as helpful "tools" for training courses.

They provide knowledge on new technical and technological developments in the electrotechnical field and electronics. They also provide better understanding of various phenomena observed in electrical installations, systems and equipments.

Each "Cahier Technique" provides an in-depth study of a precise subject in the fields of electrical networks, protection devices, monitoring and control and industrial automation systems.

The latest publications can be downloaded from the Schneider Electric internet web site.

Code: <http://www.schneider-electric.com>

Section: **Experts' place**

Please contact your Schneider Electric representative if you want either a "Cahier Technique" or the list of available titles.

The "Cahiers Techniques" collection is part of the Schneider Electric's "Collection technique".

Foreword

The author disclaims all responsibility subsequent to incorrect use of information or diagrams reproduced in this document, and cannot be held responsible for any errors or oversights, or for the consequences of using information and diagrams contained in this document.

Reproduction of all or part of a "Cahier Technique" is authorised with the compulsory mention:

"Extracted from Schneider Electric "Cahier Technique" no." (please specify).

no. 208

Electronic starters and variable speed drives

Daniel CLENET



Graduated from the Brest Ecole Nationale d'Ingénieurs in 1969. Following his first appointment working in drive systems at Alstom, he joined Telemecanique's variable speed drive group in 1973 as a design engineer. He has developed variable speed drives for DC motors for the machine tools market and drives for materials handling trucks as well as some of the first variable speed drives for asynchronous motors.

His application experience comes from dealing with end users and his role as a project manager within Schneider Electric's Industrial Applications Division. He was responsible for the launch of the Altivar drive in the USA during the years 1986 to 1990.

Electronic starters and variable speed drives

The most common way of starting asynchronous motors is directly on the line supply. This technique is often suitable for a wide variety of machines. However, it sometimes brings with it restrictions that can be inconvenient for some applications, and even incompatible with the functions required from the machine:

- The inrush current on start-up can interfere with the operation of other devices connected on the same line supply
- Mechanical shocks during starting that cannot be tolerated by the machine or may endanger the comfort and safety of users
- Acceleration and deceleration cannot be controlled
- Speed cannot be controlled

Starters and variable speed drives are able to counter these problems. Electronic technology has made them more flexible and has extended their field of application. However, it is still important to make the right choice. The purpose of this “Cahier Technique” is to provide more extensive information about these devices in order to make it easier to define them when designing equipment or when improving or even replacing a motor switchgear assembly for control and protection.

Table of contents

1 Brief history and reminders	1.1 Brief history	p. 4
	1.2 Reminders: The main functions of electronic starters and variable speed drives	p. 4
2 The main operating modes and main types of electronic drive	2.1 The main operating modes	p. 6
	2.2 The main types of drive	p. 8
3 Structure and components of electronic starters and drives	3.1 Structure	p. 10
	3.2 Components	p. 11
4 Variable speed drive/regulator for DC motor	4.1 General principle	p. 14
	4.2 Possible operating modes	p. 15
5 Frequency inverter for asynchronous motor	5.1 General principle	p. 16
	5.2 V/f operation	p. 17
	5.3 Vector control	p. 18
	5.4 Voltage power controller for asynchronous motor	p. 21
	5.5 Synchronous motor-drives	p. 23
	5.6 Stepper motor-drives	p. 23
6 Additional functions of variable speed drives	6.1 Dialog options	p. 25
	6.2 Built-in functions	p. 25
	6.3 Option cards	p. 26
7 Conclusion		p. 27

1 Brief history and reminders

1.1 Brief history

Originally, rheostatic starters, mechanical drives and rotating sets (Ward Leonard in particular) were used for starting electric motors and controlling their speed. Later, electronic starters and drives came to the fore as a modern, cost-effective, reliable and maintenance-free solution for industrial applications.

An electronic drive or starter is an energy converter, which modulates the electrical energy supplied to the motor.

Electronic starters are used solely for asynchronous motors. They are a type of voltage controller.

Variable speed drives ensure gradual acceleration and deceleration and enable speed to be matched precisely to operating conditions. Controlled rectifier type variable speed drives are used to supply power to DC motors and frequency inverters are used for AC motors.

Historically, drives for DC motors appeared first. Reliable and cost-effective frequency inverters appeared as a result of advances in power electronics and microelectronics. Modern frequency inverters can be used to supply power to standard asynchronous motors with performance levels similar to those of the best DC variable speed drives. Some manufacturers even offer asynchronous motors with electronic variable speed drives housed in a custom-made terminal box. This solution is designed for reduced power assemblies (only a few kW).

Recent developments in variable speed drives and information about current manufacturer trends appear at the end of this “Cahier Technique”. These developments are significantly expanding the drives on offer and their options.

1.2 Reminders: The main functions of electronic starters and variable speed drives

Controlled acceleration

Motor speed rise is controlled using a linear or S acceleration ramp. This ramp is usually adjustable and therefore enables a speed rise time that is appropriate for the application to be selected.

Speed control

A variable speed drive cannot be a regulator at the same time. This means that it is a rudimentary system where the control principle is developed on the basis of the electrical characteristics of the motor using power amplification but without a feedback loop and is described as “open loop”.

The speed of the motor is defined by an input value (voltage or current) known as the reference or setpoint. For a given reference value, this speed may vary depending on disturbances (variations in supply voltage, load, temperature).

The speed range is defined in relation to the nominal speed.

Speed regulation

A speed regulator is a controlled drive (see Fig. 1). It features a control system with power amplification and a feedback loop and is described as “closed loop”.

The speed of the motor is defined by a reference.

The value of the reference is continuously compared with a feedback signal, which is an image of the motor speed. This signal is supplied either by a tachogenerator or by a pulse generator connected at the motor shaft end.

If a deviation is detected following speed variation, the values applied to the motor (voltage and/or frequency) are automatically corrected in order to restore the speed to its initial value.

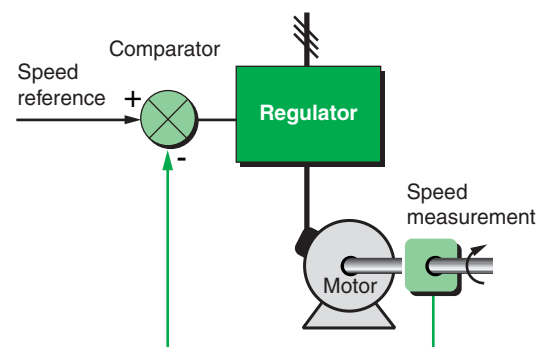

Fig. 1 : Principle of speed regulation

The feedback control renders the speed virtually impervious to disturbances.

The precision of a regulator is usually expressed as a % of the nominal value of the value to be controlled.

Controlled deceleration

When a motor is switched off, it decelerates solely on the basis of the resistive torque of the machine (natural deceleration). Electronic starters and drives can be used to control deceleration via a linear or "S" ramp, which is usually independent of the acceleration ramp.

This ramp can be adjusted in order to produce a time for deceleration from the steady state speed to an intermediate speed or zero speed:

- If the required deceleration is faster than the natural deceleration, the motor must develop a resistive torque that can be added to the resistive torque of the machine. This is described as electrical braking, which can be achieved either by restoring energy to the line supply or via dissipation in a braking resistor.
- If the required deceleration is slower than the natural deceleration, the motor must develop a motor torque greater than the resistive torque of the machine and continue to drive the load until the motor comes to a stop.

Reversal of operating direction

The majority of today's drives support this function as standard. The order of the motor supply phases is inverted automatically either by

inverting the input reference, or via a logic command on a terminal, or via information transmitted via a line supply connection.

Braking to a standstill

This type of braking stops a motor without actually controlling the deceleration ramp. For starters and variable speed drives for asynchronous motors, this is achieved economically by injecting direct current into the motor with a special power stage function. As all the mechanical energy is dissipated in the machine rotor, this braking can only be intermittent. On a drive for a DC motor, this function will be provided by connecting a resistor to the armature terminals.

Built-in protection

Modern drives generally provide thermal protection for motors and self-protection. A microprocessor uses the current measured and speed data (if motor ventilation depends on its speed of rotation) to calculate the temperature rise of the motor and sends an alarm signal or trigger signal in the event of an excessive temperature rise.

Drives, and in particular frequency inverters, are also often fitted with protection against:

- Short-circuits between phases and between phase and ground
- Overvoltages and voltage drops
- Phase unbalance
- Single-phase operation

2 The main operating modes and main types of electronic drive

2.1 The main operating modes

Depending on the electronic converter, variable speed drives can either be used to operate a motor in a single direction of rotation (in which case they are known as “unidirectional”) or to control both directions of rotation (in which case they are known as “bidirectional”).

Drives that are able to regenerate energy from the motor operating as a generator (braking mode) can be “reversible”. Reversibility is achieved either by restoring energy to the line supply (reversible input bridge) or by dissipating the energy regenerated via a resistor with a braking chopper.

Figure 2 illustrates the four possible situations in the torque-speed diagram of a machine summarized in the corresponding table.

Please note that when the machine is operating as a generator, a driving force must be applied. This state is used in particular for braking. The kinetic energy then present on the machine shaft is either transferred to the line supply or dissipated in the resistors or, for low power ratings, in the machine losses.

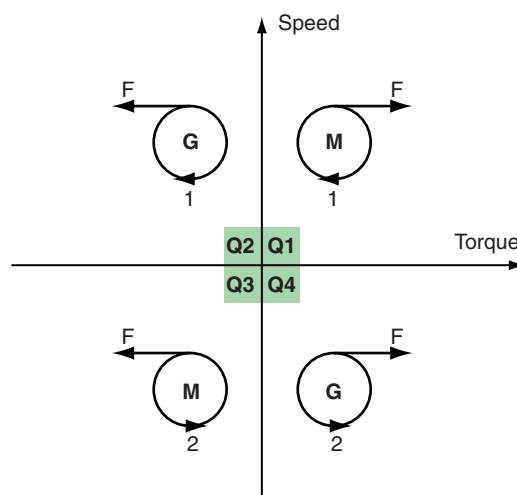

Direction of rotation	Operation	Torque -T-	Speed -n-	Product T.n	Quadrant
1 (CW)	As a motor	yes	yes	yes	1
	As a generator		yes		2
2 (CCW)	As a motor			yes	3
	As a generator	yes			4

Fig. 2 : The four possible situations of a machine in its torque-speed diagram

Unidirectional drive

This type of drive is most often non-reversible and is used for:

- A DC motor with a direct converter (AC => DC) comprising a mixed diode and thyristor bridge (see **Fig. 3a** next page)

- An AC motor with an indirect converter (with intermediate DC transformation) comprising a diode bridge at the input followed by a frequency inverter, which forces the machine to operate in quadrant 1 (see **Fig. 3b** next page). In some cases, this assembly can be used in bidirectional configurations (quadrants 1 and 3).

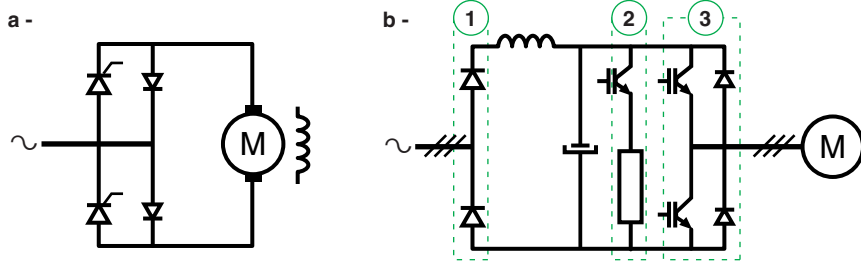

Fig. 3 : Simplified schematics: [a] direct converter with mixed bridge; [b] indirect converter with (1) input diode bridge, (2) braking device (resistor and chopper), (3) frequency inverter

An indirect converter comprising a braking chopper and a correctly dimensioned resistor is the ideal solution for instantaneous braking (deceleration or on lifting gears when the motor must generate a downward braking torque in order to hold the load).

A reversible converter is essential for long-term operation with a driving load as the load is then negative as, for example, on a motor used for braking on a test bench.

Bidirectional drive

This type of drive can be a reversible or non-reversible converter.

If it is reversible, the machine operates in all four quadrants and can tolerate significant braking.

If it is non-reversible, the machine only operates in quadrants 1 and 3.

Operation at constant torque

Operation is described as being at constant torque when the characteristics of the load are such that, in steady state, the torque required is approximately the same regardless of the speed (see Fig. 4). This operating mode is found on conveyors and kneaders. For this type of application, the drive must be able to supply a high starting torque (at least 1.5 times the

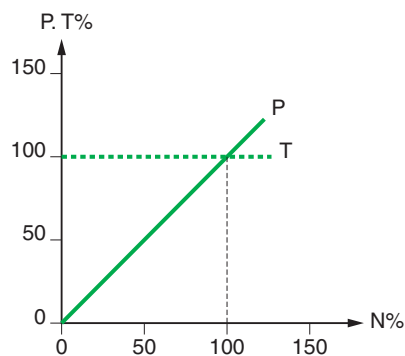

Fig. 4 : Operating curve at constant torque

nominal torque) in order to overcome static friction and to accelerate the machine (inertia).

Operation at variable torque

Operation is described as being at variable torque when the characteristics of the load are such that, in steady state, the torque required varies with the speed. This is the case in particular with helical positive displacement pumps on which the torque increases linearly with the speed (see Fig. 5a) or centrifugal machines (pumps and fans) on which the torque varies with the square of the speed (see Fig. 5b).

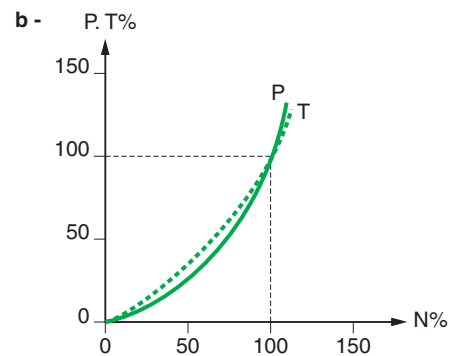
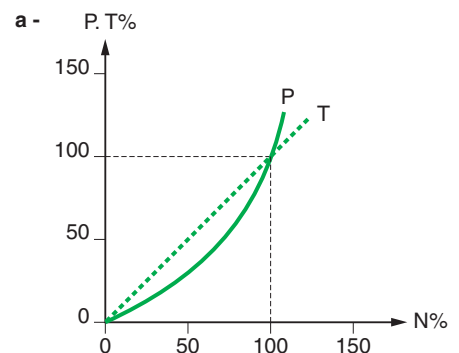

Fig. 5 : Operating curves at variable torque

For a drive designed for this type of application, a lower starting torque (usually 1.2 times the nominal motor torque) is sufficient. The drive usually has additional functions such as the option to skip resonance frequencies caused by the machine vibrating inadvertently. Operation above nominal frequency is impossible due to the overload this would impose on the motor and the drive.

Operation at constant power

This is a special case of variable torque. Operation is described as being at constant power when the torque supplied by the motor is inversely proportional to the angular speed (see Fig. 6). This is the case, for example, for a winder with an angular speed that must reduce as the winding diameter increases when the material is wound on. It is also the case for spindle motors on machine tools.

The operating range at constant power is by its nature limited, at low speed by the current

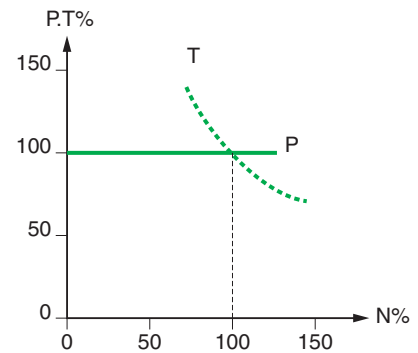

Fig. 6 : Operating curve at constant power

supplied by the drive and at high speed by the available motor torque. As a consequence, the available motor torque with asynchronous motors and the switching capacity of DC machines must be checked carefully.

2.2 The main types of drive

Only the most up-to-date drives and standard technological solutions are referred to in this section.

There are numerous types of schematic for electronic variable speed drives: subsynchronous cascade, cycloconverters, current commutators, choppers, etc. Interested readers will find an exhaustive description in the following publications: "Entraînement électrique à vitesse variable" (work by Jean Bonal and Guy Séguier describing variable speed electrical drive systems) and "Utilisation industrielle des moteurs à courant alternatif" (by Jean Bonal describing AC motors in industrial applications).

Controlled rectifier for DC motor

The rectifier supplies direct current from a single-phase or three-phase AC line supply where the average voltage value is controlled.

Power semiconductors are configured as single-phase or three-phase Graetz bridges (see Fig. 7). The bridge can be diode/thyristor (mixed) or thyristor/thyristor (full). This latter solution is the most common as it improves the form factor of the current supplied.

The DC motor usually has separate excitation, except for low power ratings, where permanent magnet motors are quite common.

This type of drive is suitable for use in all applications. The only restrictions are those imposed by the DC motor, in particular the difficulty of reaching high speeds and the maintenance required (the brushes must be replaced). DC motors and associated drives

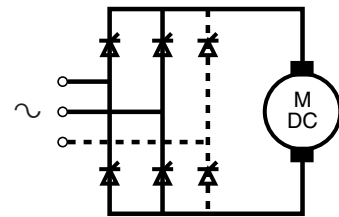

Fig. 7 : Diagram of a controlled rectifier for a DC motor

were the first industrial solutions. Their use has been declining over the past decade as frequency inverters take center stage.

Asynchronous motors are in fact more rugged and more economical than DC motors. Unlike DC motors, asynchronous motors are standardized in an IP55 enclosure and are also virtually unaffected by environmental conditions (dripping water, dust, hazardous atmospheres, etc.).

Frequency inverter for asynchronous motor

The inverter supplies a variable frequency three-phase AC rms voltage from a fixed frequency AC line supply (see Fig. 8 next page). A single-phase power supply can be used for the drive at low power ratings (a few kW) and a three-phase power supply at higher ratings. Some low-power drives can tolerate single-phase and three-phase power supplies equally. The output voltage of the drive is always three-phase. In fact, single-phase asynchronous motors are not particularly suitable for power supply via a frequency inverter.

Frequency inverters can supply power to standard cage motors with all the advantages associated with these motors: standardization, low cost, ruggedness, ingress protection, no maintenance. As these motors are self-cooled, their only operating restriction is long-term use at low speed due to the reduction in this ventilation. If this type of operation is required, a special motor fitted with a separate forced ventilation unit must be used.

Voltage controller for starting asynchronous motors

The controller supplies, from an AC line supply, a fixed frequency alternating current equal to the line supply current where control of the rms value of the voltage is achieved by modifying the trigger delay angle α of the power semiconductors - two thyristors connected head to tail in each motor phase (see Fig. 9).

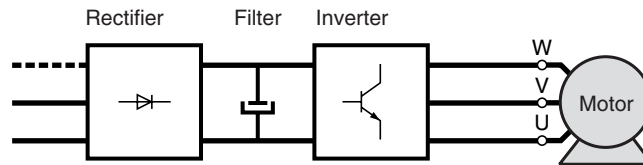

Fig. 8 : Simplified schematic of a frequency inverter

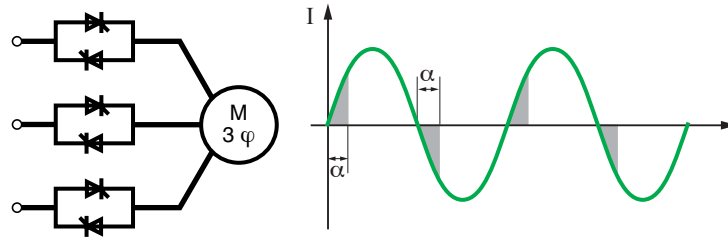

Fig. 9 : Asynchronous motor starter and form of power supply current

3 Structure and components of electronic starters and drives

3.1 Structure

Electronic starters and variable speed drives comprise two modules, which are usually housed in a single enclosure (see Fig. 10):

- A control module, which manages the operation of the device
- A power module, which supplies power to the motor in the form of electrical energy

The control module

On modern starters and drives, all functions are controlled by a microprocessor, which uses the settings, the commands sent by an operator or by a processing unit and the results of measurements such as speed, current, etc.

Along with dedicated circuits (ASICs), the microprocessors' calculation functions have made it possible to perform extremely high-performance control algorithms and in particular to recognize the parameters of the machine being driven. The microprocessor uses this information to manage the deceleration and acceleration ramps, for speed control and current limiting as well as to control power components. Protection and safety measures are processed by dedicated circuits (ASICs) or circuits integrated in power modules (IPMs).

Speed limits, ramp profiles, current limits and other settings are defined using the integrated

keypads, or via PLCs (over fieldbuses) or PCs. Similarly, the various commands (run, stop, brake, etc.) can be sent via HMIs, PLCs or PCs.

Operating parameters and alarm and fault data can be displayed using indicators, electroluminescent diodes, segment displays or LCDs. Alternatively they can be displayed remotely to supervisors via fieldbuses.

Relays, which are usually programmable, provide the following data:

- Fault (line supply, thermal, product, sequence, overload, etc.)
- Monitoring (speed threshold, pre-alarm, end of starting)

The voltages required for all measurement and control circuits are supplied via a power supply that is integrated into the drive and electrically isolated from the line supply.

The power module

The main components of the power module are:

- Power components (diodes, thyristors, IGBTs, etc.)
- Interfaces for measuring voltages and/or currents
- In most cases, a fan unit

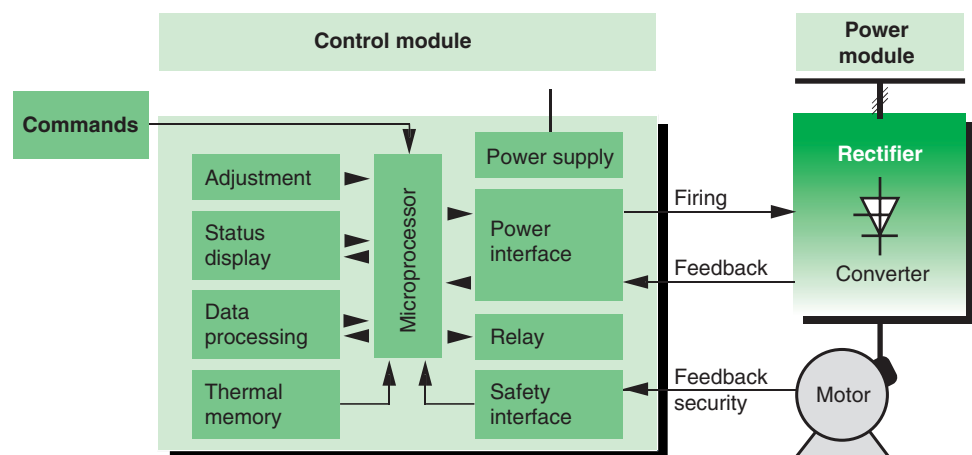

Fig. 10 : Structure of an electronic variable speed drive

3.2 Components

The power components (see Fig. 11) are discrete semiconductors and as such can be likened to static switches which can take one of two states: on or off.

These components, combined in a power module, form a converter that supplies power to an electrical motor at a variable voltage and/or variable frequency from a fixed voltage fixed frequency line supply.

Power components are the keystone of speed control and progress made in recent years has led to the development of cost-effective variable speed drives.

Reminder

Semiconductor materials such as silicon have a resistivity between that of conductors and that of insulators. Their atoms have 4 peripheral electrons. Each atom associates with 4 adjacent atoms to create a stable 8-electron structure.

A P type semiconductor is obtained by adding to pure silicon a small proportion of a substance whose atoms have 3 peripheral electrons. Another electron must therefore be added to create a structure with 8 electrons, which results in a surplus of positive charges.

An N type semiconductor is obtained by adding a substance whose atoms have 5 peripheral electrons. This therefore creates a surplus of electrons, i.e. a surplus of negative charges.

The diode

The diode is a non-controlled semiconductor comprising 2 regions, P (anode) and N (cathode), which will only permit current to be conducted in one direction, from the anode to the cathode.

It conducts current when the anode voltage is at a higher positive value than that of the cathode and therefore behaves like a closed switch. It blocks the current and behaves like an open switch if the voltage at the anode becomes less positive than that at the cathode.

The main characteristics of the diode are as follows:

- In the on state:
 - A drop in the voltage composing a threshold voltage and that due to an internal resistance
 - A maximum permissible continuous current (order of magnitude up to 5000 A rms for the most powerful components)
- In the off state, a maximum permissible voltage that may exceed 5000 V peak

The thyristor

This is a controlled semiconductor comprising four alternate layers: P-N-P-N.

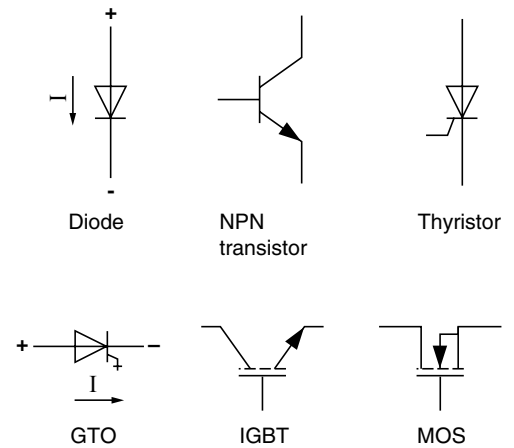

Fig. 11 : Power components

It behaves like a diode in sending an electrical pulse on a control electrode known as a “gate”. This closing (or firing) is only possible if the anode is at a voltage more positive than the cathode.

The thyristor changes to the off state when current ceases to pass through it.

The firing energy to be supplied to the gate is independent of the current to be switched. It is not necessary either to maintain a current in the gate while the thyristor is conducting.

The main characteristics of the thyristor are as follows:

- In the on state:
 - A composite voltage drop from a threshold voltage and an internal resistance
 - A maximum permissible continuous current (order of magnitude up to 5000 A rms for the most powerful components)
 - In the off state:
 - A maximum permissible reverse and forward voltage (may exceed 5000 V peak). Forward and reverse voltages are usually identical
 - A recovery time that is the minimum time during which, if a positive anode cathode voltage was applied to the component, it would refire spontaneously
 - A gate current that will fire the component
- Some thyristors are designed to operate at the line supply frequency and others, known as “high-speed” thyristors, will operate at several kHz using an extinction circuit. Some high-speed thyristors have asymmetrical forward and reverse cut-off voltages.

In standard schematics, they are usually associated with a diode connected back-to-back and semiconductor manufacturers use this special feature to increase the forward voltage that the component can tolerate in the off state. Today, these components have been replaced completely by GTOs, power transistors and in particular by IGBTs (Insulated Gate Bipolar Transistors).

The GTO (Gate Turn Off) thyristor

This is a special type of high-speed thyristor that can be turned off by its gate. A positive current supplied to the gate will cause the semiconductor to start conducting if the voltage at the anode is more positive than at the cathode. The gate current must be maintained if the GTO is to continue conducting and the voltage drop is to be limited. The thyristor is blocked by reversing the polarity of the gate current. GTOs are used on very high-power converters as they are able to control high voltages and currents (up to 5000 V and 5000 A). However, as IGBTs continue to develop, GTO market share is declining.

The main characteristics of the GTO thyristor are as follows:

- In the on state:
 - A composite voltage drop from a threshold voltage and an internal resistance
 - A holding current designed to reduce drops in the forward voltage
 - A maximum permissible continuous current
 - A cut-off current to block the current
 - In the off state:
 - Maximum permissible reverse and forward voltages, often asymmetrical as with high-speed thyristors and for the same reasons
 - A recovery time that is the minimum time during which the extinction current must be maintained to prevent spontaneous refiring
 - A gate current that will fire the component
- GTOs can operate at frequencies of several kHz

The transistor

This is a controlled bipolar semiconductor comprising 3 alternating regions, P-N-P or N-P-N. It only permits current to be conducted in one direction: from the emitter to the collector for P-N-P semiconductors and from the collector to the emitter for N-P-N semiconductors. N-P-N type transistors, often configured as "Darlington" type transistors, are capable of operating at industrial voltages.

The transistor can operate as an amplifier. The value of the current passing through it is then determined by the control current circulating in its base. However, it can also function as a

discrete static switch: open when there is no base current, closed when saturated. This second operating mode is the one used in power circuits on drives.

Bipolar transistors can be used for voltages up to 1200 V and support currents that may reach 800 V.

This component has today been replaced in converters by IGBTs.

In terms of the type of operation in which we are interested, the main characteristics of the bipolar transistor are as follows:

- In the on state:
 - A composite voltage drop from a threshold voltage and an internal resistance
 - A maximum permissible continuous current
 - A current gain (to maintain saturation of the transistor, the current injected in the base must be greater than the current circulating in the component, divided by the gain)
- In the off state, a maximum permissible forward voltage

The power transistors used in speed control can operate at frequencies of several kHz.

The IGBT

This is a power transistor controlled by a voltage applied to an electrode called a "gate" that is isolated from the power circuit, hence the name Insulated Gate Bipolar Transistor (IGBT). This component requires minute levels of energy in order to generate the circulation of high currents.

Today, this component is used as a discrete switch in most frequency inverters up to high power ratings (several MW). Its voltage/current characteristics are similar to those of bipolar transistors, although its performance levels in terms of control energy and switching frequency are significantly higher than those of other semiconductors. The characteristics of IGBTs are improving all the time and high-voltage (> 3 kV) and high-current (several hundred amps) components are now available.

The main characteristics of the IGBT are as follows:

- A control voltage enabling the component to be switched on/off
- In the on state:
 - A composite voltage drop from a threshold voltage and an internal resistance
 - A maximum permissible continuous current
- In the off state, a maximum permissible forward voltage
- IGBTs used in speed control can operate at frequencies of several tens of kHz

The MOS transistor

The operating principle of this component differs significantly from those listed above due to the modification of the electrical field in a semiconductor obtained by polarizing an isolated gate, hence the name "Metal Oxide Semiconductor". Its use in speed control is limited to low-voltage (battery-powered variable speed drives) or low-power applications because the silicon surface required to obtain a high cut-off voltage with a negligible voltage drop in the on state is too expensive to implement.

The main characteristics of the MOS transistor are as follows:

- A control voltage enabling the component to be switched on/off
- In the on state:
 - An internal resistance
 - A maximum permissible continuous current
- In the off state, a maximum permissible forward voltage (may exceed 1000 V)

MOS transistors used in speed control can operate at frequencies of several hundred kHz. They are found in virtually all switch mode power supply stages in the form of discrete components or as an integrated circuit comprising the power (MOS) and the command-control circuits.

The IPM (Intelligent Power Module)

Strictly speaking, this is not a semiconductor but a series of IGBT transistors. This module (see **Fig. 12**) combines, in a single compact housing,

an inverter bridge with IGBT transistors and the low-level electronics for controlling semiconductors:

- 7 x IGBT components (six for the inverter bridge and one for braking)
- The IGBT control circuits
- 7 x freewheel power diodes associated with the IGBTs in order to enable the current to circulate
- Protection against short-circuits, overcurrents and excessive temperatures
- The electrical isolation for this module

The diode rectifier bridge is usually integrated into this same module.

This assembly is the best way to deal with the wiring and control restrictions of IGBTs.

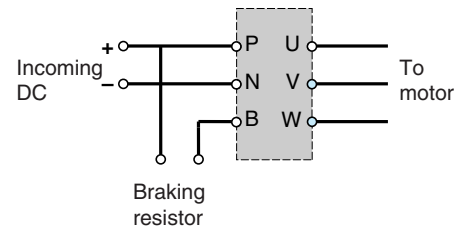

Fig. 12 : IPM (Intelligent Power Module)

4 Variable speed drive/regulator for DC motor

4.1 General principle

The Ward Leonard set was the first variable speed drive for DC motors.

This set, which comprised a drive motor (usually asynchronous) and a variable excitation DC generator, supplied power to one or more DC motors. Excitation was controlled by an electromechanical device (Amplidyne, Rototrol, Regulex) or by a static system (magnetic amplifier or electronic regulator). Today, this device is totally obsolete and has been replaced by semiconductor variable speed drives capable of performing the same operations statically with superior levels of performance.

Electronic variable speed drives are supplied with power at a fixed voltage via an AC line supply and provide the motor with a variable DC voltage. A diode bridge or a thyristor bridge (usually single-phase) powers the excitation circuit.

The power circuit is a rectifier. As the voltage to be supplied has to be variable, this rectifier must be a controlled rectifier, i.e. it must comprise power components whose conductive characteristics can be controlled (thyristors). The output voltage is controlled by limiting to a greater or lesser extent the conduction time during each alternation. The longer the triggering of the thyristor is delayed in relation to the zero of the alternation, the lower the average voltage value and therefore the lower the motor speed (remember that a thyristor will shut down automatically when the current crosses zero).

For low-power drives or drives powered by a battery pack, the power circuit, which may comprise power transistors (chopper), will vary the DC output voltage by adjusting the conduction time. This operating mode is known as PWM (Pulse Width Modulation).

Regulation

Regulation is the precision maintenance of the value imposed in spite of disturbances (variation of resistive torque, power supply voltage, temperature). However, during acceleration or in the event of an overload, the current must not reach a value that may endanger the motor or

the power supply device. An internal control loop in the drive maintains the current at an acceptable value. This limit can be accessed in order to be adjusted as appropriate for the characteristics of the motor.

The reference speed is determined by an analog or digital signal supplied via a fieldbus or any other device, which provides a voltage image of this required speed. The reference may be fixed or vary during the cycle.

Adjustable acceleration and deceleration ramps gradually apply the reference voltage corresponding to the required speed. This ramp can follow any profile. The adjustment of the ramps defines the duration of the acceleration and deceleration.

In closed loop mode, the actual speed is measured continuously by a tachogenerator or a pulse generator and compared with the reference. If a deviation is detected, the control electronics will correct the speed. The speed range extends by several revolutions per minute until the maximum speed is reached. In this variation range, it is easy to achieve precision rates better than 1% in analog regulation and better than 1/1000 in digital regulation, taking into account all possible variations (no-load/on-load, voltage variation, temperature variation, etc.).

This type of regulation can also be implemented using the motor voltage measured taking into account the current passing through the motor. In this case, performance levels are slightly lower, both in the speed range and in terms of precision (several % between no-load operation and on-load operation).

Reversal of the operating direction and regenerative braking

In order to reverse the operating direction, the armature voltage must be inverted. This can be done using contactors (this solution is now obsolete) or statically by reversing the output polarity of the variable speed drive or the polarity of the excitation current. The use of this latter solution is rare due to the time constant of the field coil.

If controlled braking is required or necessitated by the nature of the load (driving torque), energy must be fed back to the line supply. During braking, the drive acts as an inverter or, in other words, the current circulating is negative.

Drives capable of performing these two functions (reversal and regenerative braking) feature two bridges connected back-to-back (see Fig. 13). Each of these bridges can be used to invert the voltage and current as well as the sign for the energy circulating between the line supply and the load.

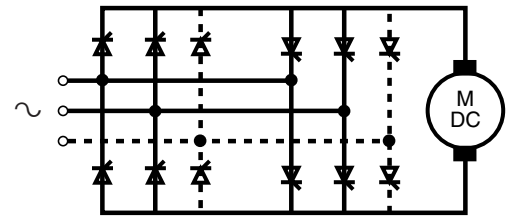

Fig. 13 : Schematic of a drive with reversal and regenerative braking for a DC motor

4.2 Possible operating modes

Operation at “constant torque”

With constant excitation, the speed of the motor is determined by the voltage applied to the motor armature. Speed control is possible between standstill and the nominal voltage of the motor, which is selected on the basis of the AC supply voltage.

The motor torque is proportional to the armature current and the nominal torque of the machine can be obtained continuously at all speeds.

Operation at “constant power”

When the machine is supplied with power at its nominal voltage, its speed can still be increased by reducing the excitation current. In this case, the variable speed drive must feature a controlled rectifier bridge that powers the excitation circuit. The armature voltage will remain fixed and equal to the nominal voltage and the excitation current is adjusted in order to reach the required speed.

The power is expressed as

$$P = E \times I$$

where

E is the supply voltage and

I is the armature current.

For a given armature current the power will therefore be constant throughout the speed range, but the maximum speed is limited by two parameters:

- The mechanical limit associated with the armature and in particular the maximum centrifugal power that can be tolerated by the commutator
- The machine’s switching options, which are, in general, more restrictive

The motor manufacturer must therefore be urged to select the correct motor, in particular in respect of the speed range at constant power.

5 Frequency inverter for asynchronous motor

5.1 General principle

The frequency inverter, which is powered at fixed voltage and frequency via the line supply, provides a variable voltage and frequency AC power supply to the motor as appropriate for its speed requirements.

Constant flux must be maintained in order to facilitate the supply of power to an asynchronous motor at constant torque regardless of speed. This requires the voltage and frequency to increase simultaneously in equal proportions.

Composition

The power circuit comprises a rectifier and an inverter, which uses the rectified voltage to produce a variable amplitude voltage and frequency (see Fig. 8).

In order to meet the requirements of the EC (European Community) directive and associated standards, a "line supply" filter is installed upstream of the rectifier bridge.

The rectifier is usually fitted with a diode rectifier bridge and a filter circuit comprising one or more capacitors depending on the power rating. A limitation circuit controls the current on drive start-up. Some converters use a thyristor bridge to limit the inrush current of these filter capacitors, which are loaded to a value that is approximately equal to the peak value of the line supply sine wave (approx. 560 V at 400 V three-phase).

Note: Although discharge circuits are fitted, these capacitors may retain a dangerous voltage once the line voltage has been disconnected. Work must only be carried out on this type of product by trained personnel with knowledge of the essential precautions to be taken (additional discharge circuit or knowledge of waiting periods).

The inverter bridge connected to these capacitors uses six power semiconductors (usually IGBTs) and associated freewheel diodes.

This type of drive is designed to power asynchronous cage motors. Telemecanique's Altivar brand can be used to create a miniature electrical supply network providing a variable voltage and frequency capable of supplying power to a single motor or to several motors in parallel. It comprises:

- A rectifier with filter capacitor
- An inverter with 6 IGBTs and 6 diodes
- A chopper, which is connected to a braking resistor (usually external to the product)
- IGBT transistor control circuits
- A control unit based around a microprocessor, which is used to control the inverter
- Internal sensors for measuring the motor current, the DC voltage at the capacitor terminals and in some cases the voltages at the terminals of the rectifier bridge and the motor as well as all values required to control and protect the motor-drive unit
- A power supply for low-level electronic circuits

This power supply is provided by a switching circuit connected to the filter capacitor terminals in order to make use of this energy reserve. Altivar drives use this feature to avoid the effects of transient line supply fluctuations, thereby achieving remarkable performance levels on line supplies subject to significant disturbances.

Speed control

The output voltage is generated by switching the rectified voltage using pulses with a duration, and therefore a width, which is modulated so that the resulting alternating current will be as sinusoidal as possible (see Fig. 14). This technique, known as PWM (Pulse Width Modulation), conditions regular rotation at low speed and limits temperature rises.

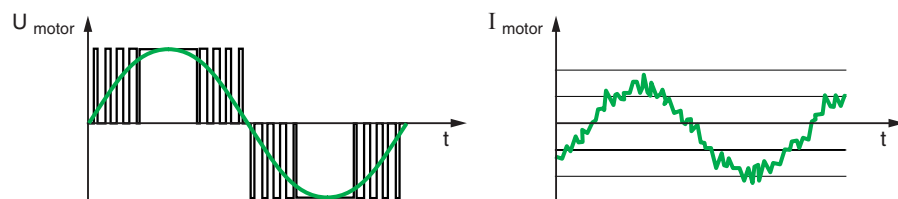

Fig. 14 : Pulse width modulation

The modulation frequency selected is a compromise: it must be high enough to reduce current ripple and acoustic noise in the motor without significantly increasing losses in the rectifier bridge and in the semiconductors. Two ramps control acceleration and deceleration.

Built-in protection

The drive provides self-protection and protects the motor against excessive temperature rises by disabling it until the temperature falls back to an acceptable level.

It also provides protection against any type of disturbance or problem that may affect the operation of the unit, such as overvoltages or undervoltages or the loss of an input or output phase.

In some ratings, the rectifier, the inverter, the chopper, the control and protection against short-circuits are housed in a single IPM.

5.2 V/f operation

In this type of operation, the speed reference imposes a frequency on the inverter and consequently on the motor, which determines the rotation speed. There is a direct ratio between the power supply voltage and the frequency (see Fig. 15). This operation is often described as operation at constant V/f or scalar

operation. If no compensation is applied, the actual speed varies with the load, which limits the operating range. Summary compensation can be used to take account of the internal impedance of the motor and to limit the on-load speed drop.

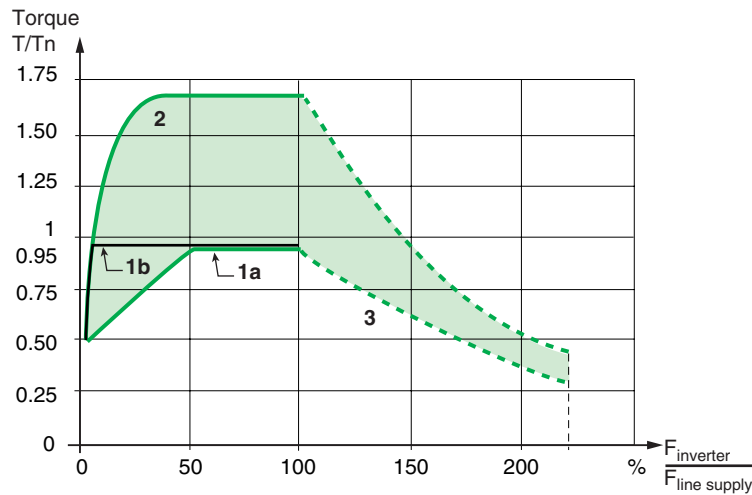

Fig. 15 : Torque characteristics of a drive (Altivar 66 – Telemecanique)

1 – continuous useful torque self-cooled motor **(a)** and forced-cooled motor **(b)**

2 – transient overtorque (< 1.7 T_n during 60 s)

3 – overspeed torque at constant power

5.3 Vector control

Performance levels can be significantly increased by using control electronics based on flux vector control (FVC) (see Fig. 16). The majority of today's drives feature this function as standard. Knowing or estimating the machine parameters enables the speed sensor to be omitted from the majority of applications. In this case, a standard motor can be used subject to the usual restriction in relation to long-term operation at low speed.

The drive generates information from the values measured at the machine terminals (voltage and current).

This control mode enables acceptable levels of performance to be achieved without increasing costs.

To achieve these levels of performance, some knowledge of the machine parameters is required. On commissioning, the machine troubleshooter must in particular apply the characteristics indicated on the motor rating plate to the drive adjustment parameters.

These include:

- UNS: Nominal motor voltage
- FRS: Nominal stator frequency
- NCR: Nominal stator current
- NSP: Nominal speed
- COS: Motor cosine

The drive uses these values to calculate the rotor characteristics (L_m , T_r).

Drive with sensorless flux vector control

On power-up, a drive with sensorless flux vector control (such as Telemecanique's ATV58F) performs auto-tuning to determine the stator parameters R_s , L_f . This measurement can be taken with the motor connected to the mechanism. The duration will vary from 1 to 10 s depending on the motor power. These values are stored and can be used by the product to derive control ratios.

The oscillogram in Figure 17 next page illustrates the acceleration of a motor loaded to its nominal torque and powered by a sensorless drive. You will note that the nominal torque is reached quickly (in less than 0.2 s) and that the acceleration is linear. Nominal speed is reached in 0.8 s.

Drive with flux vector control in closed loop mode with sensor

Another option is flux vector control in closed loop mode with sensor. This solution uses Park transformation and can be used to control the current (I_d) that provides the flux in the machine and the current (I_q) that provides the torque

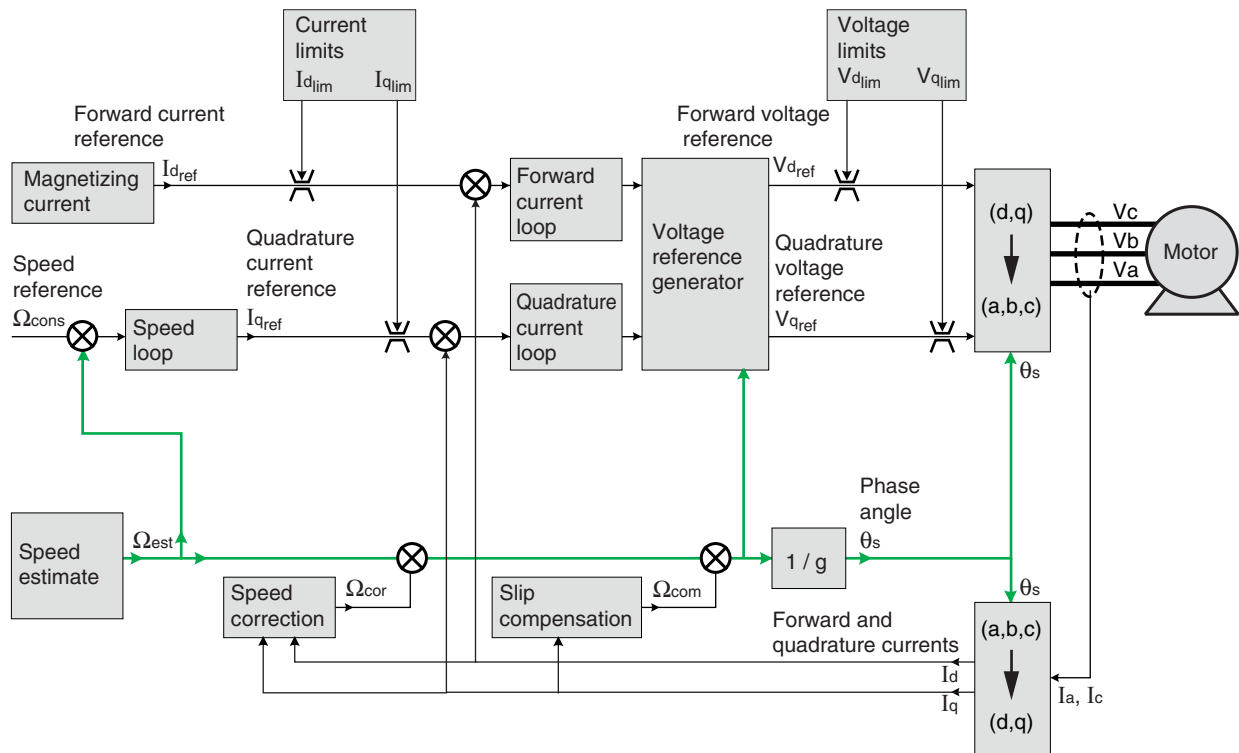

Fig. 16 : Simplified schematic of a drive with flux vector control

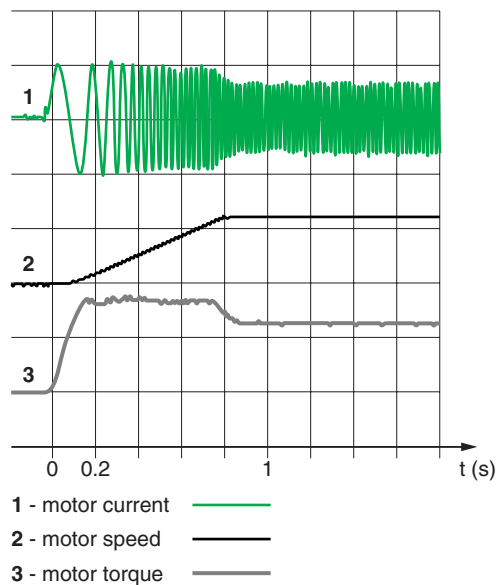

Fig. 17 : Characteristics of a motor on power-up via a drive with sensorless flux vector control (Telemecanique ATV58F type)

independently (equal to the product $I_d \times I_q$). The motor is controlled in the same way as a DC motor. This solution (see Fig. 18) meets the requirements of complex applications: high dynamics in the event of transient phenomena, speed precision, nominal torque on stopping.

The maximum transient torque is equal to 2 or 3 times the nominal torque depending on the type of motor. In addition, the maximum speed often reaches double the nominal speed or more if permitted by the motor mechanics.

This type of control also permits very high passbands and performance levels comparable with and even superior to the best DC drives. On the other hand, the motor used is not a standard design due to the presence of a sensor and, where appropriate, forced ventilation.

The oscillogram in Figure 19 next page illustrates the acceleration of a motor loaded to its nominal torque powered by a drive with flux vector control with sensor. The time scale is 0.1 s per division. Compared with the same product without a sensor, the increase in performance levels is significant. Nominal torque is reached after 80 ms and the speed rise time under the same load conditions is 0.5 s.

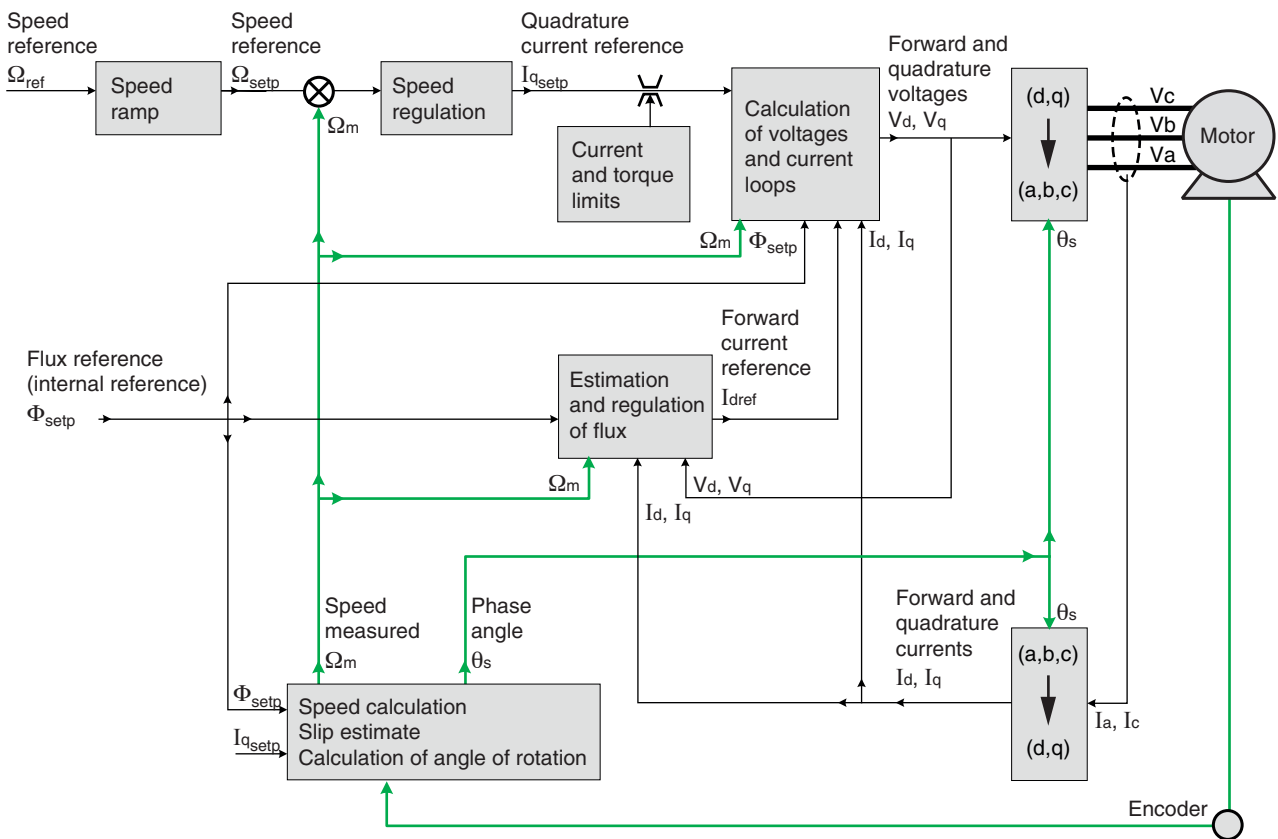

Fig. 18 : Simplified schematic of a drive with flux vector control with sensor

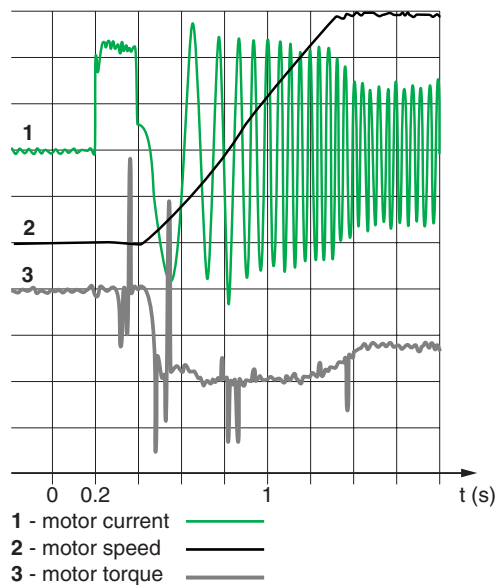

Fig. 19 : Oscillogram for the acceleration of a motor loaded to its nominal torque powered by a drive with flux vector control (Telemecanique ATV58F type)

By way of conclusion, the table in **Figure 20** compares the respective performance levels of a drive in the three possible configurations.

Reversal of operating direction and braking

The operating direction is reversed by sending an external command (either to an input designated for this purpose or by a signal on a communication bus), which reverses the operating sequence of the inverter components, thereby reversing the operating direction of the motor. A number of operational scenarios are possible.

- Scenario 1: Immediate reversal of the control direction of the semiconductors

If the motor is still rotating when the operating direction is reversed, this will produce significant slip and the current in the drive will rise to its maximum possible level (internal limiting). The braking torque is low due to the significant slip and the internal regulation will reduce the speed reference considerably. Once the motor reaches zero speed, the speed will reverse by following

the ramp. The surplus energy not absorbed by the resistive torque and the friction is dissipated in the rotor.

- Scenario 2: Reversal of the control direction of the semiconductors preceded by deceleration with or without ramp

If the resistive torque of the machine is such that natural deceleration is faster than the ramp set by the drive, the drive will continue to supply energy to the motor. The speed will gradually decrease and reverse.

In contrast, if the resistive torque of the machine is such that natural deceleration is slower than the ramp set by the drive, the motor will act as a hypersynchronous generator and restore the energy to the drive. However, because the presence of the diode bridge prevents the energy being fed back to the line supply, the filter capacitors will charge, the voltage will rise and the drive will lock. To avoid this, a resistor must be connected to the capacitor terminals via a chopper in order to limit the voltage to an appropriate value. The braking torque will then only be limited by the capacities of the drive, meaning that the speed will gradually decrease and reverse.

For this type of application, the drive manufacturer supplies braking resistors dimensioned in accordance with the motor power and the energy to be dissipated. As in most cases the chopper is included as standard with the drive, only the presence of a braking resistor will single out a drive capable of controlled braking. Therefore, this type of braking is particularly economical. It follows that this type of operation can be used to decelerate a motor to standstill without necessarily having to reverse the direction of rotation.

Dynamic DC injection braking

Economical braking can be achieved easily by operating the output stage of the drive as a chopper, which injects direct current into the windings. The braking torque is not controlled and is fairly ineffective, particularly at high speeds. Therefore, the deceleration ramp is not controlled. Nevertheless, this is a practical solution for reducing the natural stopping time of the machine. As the energy is dissipated in the rotor, this type of operation is, by its nature, rare.

	Scalar control	With sensorless flux vector control	With flux vector control and sensor
Speed range	1 to 10	1 to 100	1 to 1000
Passband	5 to 10 Hz	10 to 15 Hz	30 to 50 Hz
Speed precision	± 1 %	± 1 %	± 0.01 %

Fig. 20 : Respective performance levels for a drive in the three possible configurations (Telemecanique ATV58F type)

Possible operating modes

■ Operation at “constant torque”

As the voltage supplied by the drive can vary and insofar as flux in the machine is constant (constant V/f ratio or even better with flux vector control), motor torque will be approximately proportional to the current and it will be possible to obtain the nominal torque of the machine throughout the speed range (see Fig. 21). However, long-term operation at low speed is only possible if the motor is provided with a forced ventilation unit, and this requires a special motor. Modern drives feature protection circuits, which create a thermal image of the motor as a function of the current, the operating cycles and the rotation speed, thereby protecting the motor.

■ Operation at “constant power”

When the machine is powered at its nominal voltage, it is still possible to increase its speed by supplying it with a frequency greater than that of the line supply. However, because the output voltage of the inverter cannot exceed that of the line supply, the available torque decreases in inverse proportion to the increase in speed (see Fig. 21). Above its nominal speed, the motor ceases to operate at constant torque and operates at constant power ($P = Cw$) insofar as

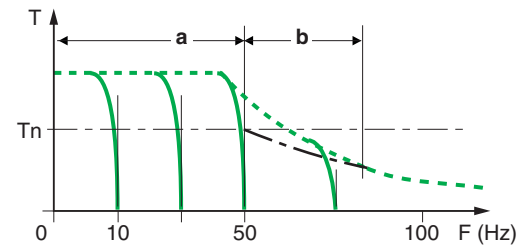

Fig. 21 : Torque of an asynchronous motor at constant load powered by a frequency inverter [a] - operating zone at constant torque, [b] - operating zone at constant power

this is permitted by the natural characteristic of the motor.

The maximum speed is limited by two parameters:

- The mechanical limit associated with the rotor
- The available torque reserve. For an asynchronous machine powered at constant voltage, whereby the maximum torque varies with the square of the speed, operation at “constant power” is only possible in a limited speed range determined by the characteristic of the machine’s own torque.

5.4 Voltage power controller for asynchronous motor

This voltage control device, which can be used for lighting and heating, can only be used with resistive cage or slip-ring asynchronous motors (see Fig. 22). The majority of these asynchronous motors are three-phase, although some are single-phase for low power ratings (up to approx. 3 kW). Often used as a soft start/soft stop unit, provided that a high starting torque is not required, a power controller can be used to limit the inrush

current, the resulting voltage drop and the mechanical shocks caused by the sudden occurrence of torque.

The most common applications of this type are starting centrifugal pumps and fans, belt conveyors, escalators, car wash gantries, machines fitted with belts, etc. and in speed control on very low power motors or universal motors such as those in electrolifting tools.

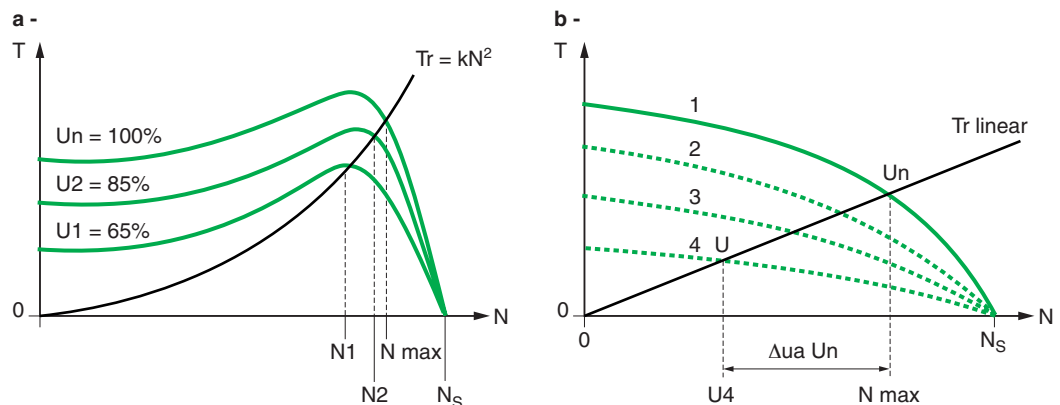

Fig. 22 : Available torque for an asynchronous motor powered at variable voltage and a parabolic resistive torque load (fan) [a] - squirrel cage motor, [b] - resistive cage motor

However, for some applications, such as speed control on small fans, power controllers have all but been replaced by frequency inverters, which are more economical during operation.

In the case of pumps, the soft stop function can also be used to eliminate pressure surges.

However, some caution must be exercised when selecting this type of speed control. When a motor slips, its losses are actually proportional to the resistive torque and inversely proportional to the speed. A power controller works on the principle of reducing the voltage in order to balance the resistive torque to the required speed. The resistive cage motor must therefore be able, at low speed, to dissipate its losses (small motors up to 3 kW are usually suitable for these conditions). Above this, a forced-cooled motor is usually required. For slip-ring motors, the associated resistors must be dimensioned in accordance with the operating cycles. The decision is left to the specialist, who will select the motor according to the operating cycles.

Three types of starter are available on the market: starters with one controlled phase in low power ratings, starters with two controlled phases (the third being a direct connection), or starters with all phases controlled. The first two systems must only be used for non-severe operating cycles due to the increased harmonic ratio.

General principle

The power circuit features 2 thyristors connected head to tail in each phase (see Fig. 9). Voltage variation is achieved by varying the conduction time of these thyristors during each alternation. The longer triggering is delayed, the lower the value of the resulting voltage.

Thyristor triggering is controlled by a microprocessor, which also performs the following functions:

- Control of the adjustable voltage rise and fall ramps; the deceleration ramp can only be followed if the natural deceleration time of the driven system is longer
- Adjustable current limit
- On starting torque
- Controlled braking via DC injection
- Protection of the drive against overloads
- Protection of the motor against overheating due to overloads or frequent starting
- Detection of phase unbalance, phase failure or thyristor faults

A control panel, which displays various operating parameters, provides assistance during commissioning, operation and maintenance.

Some power controllers such as the Altistart (Telemecanique) can control starting and stopping of:

- A single motor
- A number of motors simultaneously subject to rating limits
- A number of motors in succession by means of switching. In steady state, each motor is powered directly from the line supply via a contactor.

Only the Altistart features a patented device that can be used to estimate the motor torque, thereby enabling linear acceleration and deceleration and, if necessary, limiting the motor torque.

Reversal of operating direction and braking

The operating direction is reversed by inverting the starter input phases. Counter-current braking is then applied and all the energy is dissipated in the machine rotor. Therefore, operation is by its nature intermittent.

Dynamic DC injection braking

Economical braking can be achieved easily by operating the output stage of the starter as a rectifier, which injects direct current into the windings. The braking torque is not controlled and braking is fairly ineffective, particularly at high speeds. Therefore, the deceleration ramp is not controlled. Nevertheless, this is a practical solution for reducing the natural stopping time of the machine. As the energy is dissipated in the rotor, this type of operation is also rare.

5.5 Synchronous motor-drives

General principle

Synchronous motor-drives (see Fig. 23) combine a frequency inverter and a permanent magnet synchronous motor fitted with a sensor.

These motor-drives are designed for specific markets such as robots or machine tools, where a low volume of motors, high-speed acceleration and an extended passband are required.

The motor

The motor rotor is fitted with rare earth permanent magnets in order to achieve increased field strength in a reduced volume. The stator features three-phase windings. These motors can tolerate significant overload currents in order to achieve high-speed acceleration. They are fitted with a sensor in order to indicate the angular position of the motor poles to the drive, thereby ensuring that the windings are switched.

The drive

In design terms, the drive operates in the same way as a frequency inverter.

It also features a rectifier and an inverter with pulse width modulation (PWM) transistors, which restores an output current in sine form.

It is common to find several drives of this type powered by a single DC source. Therefore, on a machine tool, each drive controls one of the motors connected to the machine axes.



Fig. 23 : Photograph of a synchronous motor-drive (Schneider Electric Lexium servodrive + motor)

A common DC source powers this drive assembly in parallel.

This type of installation enables the energy generated by the braking of one of the axes to be made available to the assembly.

As in frequency inverters, a braking resistor associated with a chopper can be used to dissipate the excess braking energy.

The electronics servocontrol functions, low mechanical and electrical time constants, permit accelerations and more generally passbands that are very high, combined with simultaneous high speed dynamics.

5.6 Stepper motor-drives

General principle

Stepper motor-drives combine power electronics similar in design to a frequency inverter with a

stepper motor (see Fig. 24). They operate in open loop mode (sensorless) and are designed for use in position control applications.

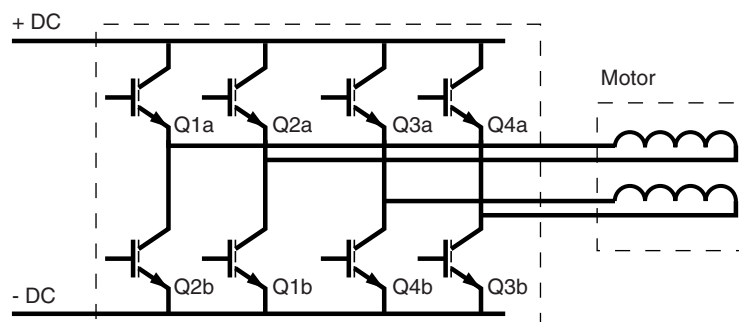

Fig. 24 : Simplified schematic of a drive for a bipolar stepper motor

The motor

The motor can be a variable reluctance motor, a permanent magnet motor or a combination of the two (see "Cahier Technique" no. 207 "Introduction aux moteurs électriques").

The drive

In design terms, the drive is similar to a frequency inverter (rectifier, filters and bridge comprising power semiconductors).

However, in terms of operation, it is fundamentally different insofar as its purpose is to inject a constant direct current into the windings. Sometimes, it uses pulse width modulation (PWM) to improve performance levels, in particular the rise time of the current (see Fig. 25), which enables the operating range to be extended.

Micro-step operation (see Fig. 26) can be used to artificially multiply the number of possible positions of the rotor by generating successive steps in the coils during each sequence. The currents in the two coils therefore resemble two alternating currents offset by 90°. The resulting field is the vector composition of the fields created by the 2 coils. The rotor therefore takes

all possible intermediate positions. The diagram below illustrates the power supply currents of coils B1 and B2 and the positions of the rotor are represented by the vector.

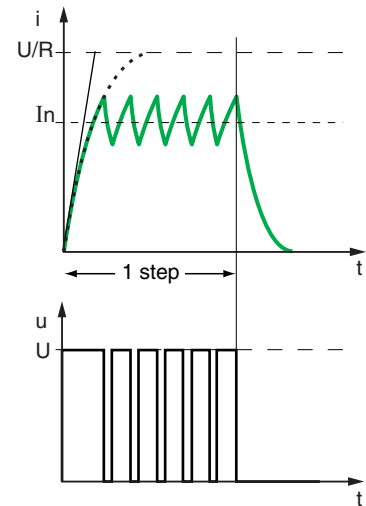

Fig. 25 : Current form resulting from PWM control

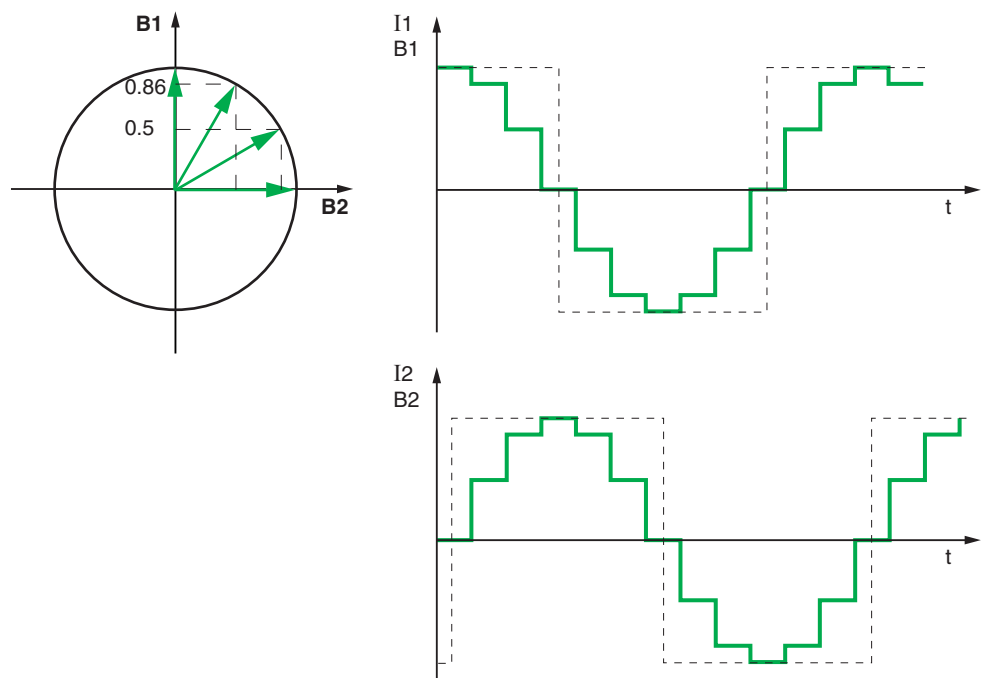

Fig. 26 : Diagram, current curves and step principle for micro-step control of a stepper motor-drive

6 Additional functions of variable speed drives

6.1 Dialog options

In order to ensure that the motor operates correctly, the drives are fitted with a number of sensors for monitoring the voltage, the “motor” currents and the thermal state of the motor. This information, which is essential for the drive, can be useful for operation.

The latest drives and starters feature dialog functions based on fieldbuses. This provides a means of generating information that is used by a PLC and a supervisor to control the machine. The PLC also uses the same channel to provide control information in the same way.

The information transmitted includes:

- Speed references
- Run or stop commands
- Initial drive settings or modifications of these settings during operation
- The drive status (run, stop, overload, fault)
- Alarms
- The motor status (speed, torque, current, temperature)

These dialog options are also used in connection with a PC in order to simplify settings on start-up (download) or to archive initial settings.

6.2 Built-in functions

In order to be compatible for use in a large number of applications, the drives feature a significant number of adjustments and settings, including:

- Acceleration and deceleration ramp times
- Ramp profiles (linear, S or U)
- Ramp switching, which can be used to obtain two acceleration or deceleration ramps in order, for example, to permit a smooth approach
- Reduction of the maximum torque controlled using a logic input or a reference
- Jog operation
- Management of brake control for lifting applications
- Choice of preset speeds
- The presence of summed inputs, which can be used to sum speed references
- Switching of references present at the drive input
- The presence of a PI regulator for simple servocontrol (speed or flow rate for example)
- Automatic stop following loss of line supply enabling the motor to brake
- Automatic catching a spinning load with detection of motor speed for catch on the fly
- Thermal protection of the motor using an image generated in the drive

- Option to connect PTC thermal sensors integrated into the motor
- Skipping of the machine resonance frequency, the critical speed is skipped in order to prevent operation at this frequency
- Time-delayed locking at low speed in pumping applications where the fluid is used to lubricate the pump and prevent seizing

These functions are increasingly being included as standard on sophisticated drives (see **Fig. 27**).



Fig. 27 : Photograph of a drive featuring numerous built-in functions (Telemecanique ATV58H)

6.3 Option cards

For more complex applications, manufacturers can supply option cards, which can be used either for special functions, e.g. flux vector control with sensor, or as dedicated application-specific cards. These types of card include:

- “Pump switching” cards as a cost-effective means of setting up a pumping station comprising a single drive that supplies power to a number of motors in succession
- “Multi-motor” cards
- “Multi-parameter” cards, which can be used to automatically switch preset drive parameters
- Special cards developed to meet a specific user requirement

Some manufacturers also offer PLC cards built into the drive, which can be used for simple applications. This provides the operator with programming instructions and inputs and outputs for setting up small automated systems where the presence of a PLC cannot be justified.

7 Conclusion

As the selection of a variable speed drive is inextricably linked with the type of load driven and the target performance levels, the definition and selection of any variable speed drive must include an analysis of the operational requirements of the equipment and performance levels required of the motor itself.

Constant torque, variable torque, constant power, flux vector control, bidirectional drive, etc. are all terms that feature heavily in manufacturer documentation. In essence, this is all the data you will need in order to identify the most appropriate drive.

Selecting the wrong drive can result in disappointing operation. Equally, it is essential to consider the required speed range in order to select the most suitable motor/drive combination.

The information in this “Cahier Technique” will ensure that you have all the necessary data to hand to help you make the right choice when consulting manufacturers’ documentation or - a more reliable option - when seeking specialist advice in order to select the drive that will give you the best price/performance ratio.

Schneider Electric

Direction Scientifique et Technique,
Service Communication Technique
F-38050 Grenoble cedex 9
Fax: 33 (0)4 76 57 98 60
E-mail : fr-tech-com@mail.schneider.fr

Transl: Lloyd International - Tarporley - Cheshire - GB.
DTP: AXESS - Valence (26)
Edition: Schneider Electric
- 20 € -